

Data Sheet

Electric expansion valve Type **AKV 15** and **AKV 20**

For liquid injection into evaporators

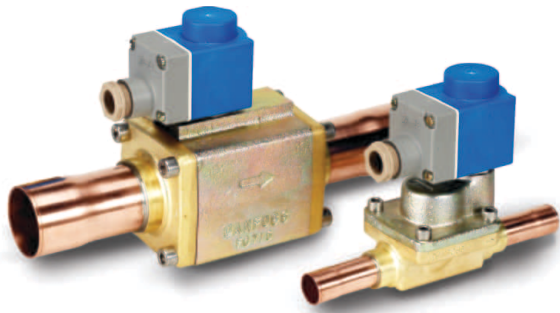

AKV are electrically operated expansion valves designed for refrigerating plants.

The AKV valves are normally controlled by a controller from Danfoss' range of ADAP- KOOL® controllers.

The AKV valves are supplied as a component programme, as follows:

- Separate valve
- Separate coil with terminal box or cable
- Spare parts in the form upper part, orifice and filter

Valve capacity is indicated with a number forming part of the type designation. The number represents the size of the orifice of the valve in question. A valve with orifice 3 will for example be designated AKV 15-3. The orifice assembly is replaceable.

Features

- Refrigerants: R134a, R22, R23, R404A, R407A, R407C, R407F, R407H, R410A, R422B, R422D, R438A, R448A, R449A, R449B, R450A, R452A, R463A, R507, R513A, R513B, R515A, R515B, R744.
- For a complete list of approved refrigerants, visit <https://store.danfoss.com/> and search for individual code numbers, where refrigerants are listed as part of technical data.
- The valve requires no adjustment
- Wide regulation range Replaceable orifice assembly
- Both expansion valve and solenoid valve
- Wide range of AC and DC coils

Function

Figure 1: Function

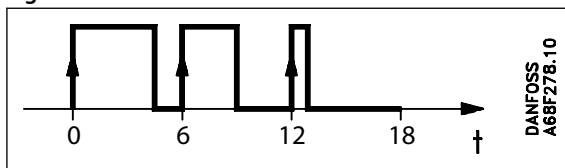

The valve capacity is regulated by means of pulse-width modulation. Within a period of six seconds a voltage signal from the controller will be transmitted to and removed from the valve coil. This makes the valve open and close for the flow of refrigerant.

The relation between this opening and closing time indicates the actual capacity. If there is an intense need for refrigeration, the valve will remain open for almost all six seconds of the period. If the required amount of refrigeration is modest, the valve will only stay open during a fraction of the period.

The amount of refrigeration needed is determined by the controller. When no refrigeration is required, the valve will remain closed and thus function as a solenoid valve.

Product specification

Technical data

Table 4: Technical data

Valve type	AKV 15	AKV 20
Tolerance of coil voltage (coil dependent)	10 / - 15%	10 / - 15%
Enclosure to IEC 529	Max. IP67	Max. IP67
Working principle	Pulse Width Modulation (PWM)	
Recommended period of time	6 sec.	6 sec.
Capacity (R404A/R507)	14 – 85 kW / 3.98 – 24.17 ton	56 – 530 kW / 15.92 – 150.70 ton
Regulation range (Capacity range)	10 – 100%	10 – 100%
Connection	Solder	Solder or weld
Evaporating temperature	- 50 – 60 °C / -58 – 140 °F	- 40 – 60 °C / -104 – 140 °F
Ambient temperature (coil dependent)	- 40 – 50 °C / -104 – 122 °F	- 40 – 50 °C / -104 – 122 °F
MOPD (Max. Opening Pressure Differential)	22 bar / 319 psig	18 bar / 261 psig
Filter, replaceable	External 100 µm	External 100 µm
Max. working pressure	AKV 15-1 – 15-4: 46 barg / 667 psig	AKV 20-1 – 20-5: 28 barg / 406 psig

Filter

Figure 2: Filter

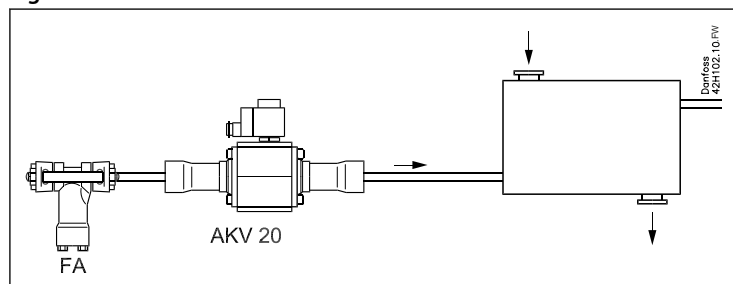

On plants using AKV 15 or AKV 20 a filter must be mounted in front of AKV 15 and AKV 20.

Capacity

Table 5: AKV 15

Valve type	Rated capacity ⁽¹⁾														kv value[m ³ /h]	Connections Solder ODF		
	R22		R134a		R407C		R404A/ R507		R407A		R410A		R744			Inlet x outlet [in]	Inlet x outlet [mm]	Multipack Code no.
	[kW]	[TR]	[kW]	[TR]	[kW]	[TR]	[kW]	[TR]	[kW]	[TR]	[kW]	[TR]	[kW]	[TR]				
AKV 15-1	25.7	7.3	19.9	5.66	27.1	7.72	18.1	5.14	25.4	7.23	30.1	8.56	32.7	9.3	0.25	¾ x ¾	-	068F5000
	25.7	7.3	19.9	5.66	27.1	7.72	18.1	5.14	25.4	7.23	30.1	8.56	32.7	9.3	0.25	-	18 x 18	068F5001
	25.7	7.3	19.9	5.66	27.1	7.72	18.1	5.14	25.4	7.23	30.1	8.56	32.7	9.3	0.25	¾ x ¾	-	068F5035 ⁽²⁾
AKV 15-2	41.1	11.7	31.8	9.03	43.3	12.3	28.9	8.23	40.6	11.6	48.1	13.7	52.4	14.9	0.4	¾ x ¾	-	068F5005
	41.1	11.7	31.8	9.03	43.3	12.3	28.9	8.23	40.6	11.6	48.1	13.7	52.4	14.9	0.4	-	18 x 18	068F5006
	41.1	11.7	31.8	9.03	43.3	12.3	28.9	8.23	40.6	11.6	48.1	13.7	52.4	14.9	0.4	¾ x ¾	-	068F5036 ⁽²⁾
AKV 15-3	64.5	18.3	49.9	14.1	68.1	19.4	45.4	12.9	63.8	18.1	75.7	21.5	82.6	23.5	0.63	7/8 x 7/8	-	068F5010
	64.5	18.3	49.9	14.1	68.1	19.4	45.4	12.9	63.8	18.1	75.7	21.5	82.6	23.5	0.63	7/8 x 7/8	-	068F5037 ⁽²⁾
AKV 15-4	102	29	78.6	22.3	107	30.5	71.9	20.5	101	28.6	120	34.1	131	37.2	1	1 1/8 x 1 1/8	-	068F5015
	102	29	78.6	22.3	107	30.5	71.9	20.5	101	28.6	120	34.1	131	37.2	1	-	28 x 28	068F5016
	102	29	78.6	22.3	107	30.5	71.9	20.5	101	28.6	120	34.1	131	37.2	1	1 1/8 x 1 1/8	-	068F5038 ⁽²⁾

Electric expansion valve, Type AKV 15 and AKV 20

⁽¹⁾ Rated capacities are based on:
 Condensing temperature $t_c = 38\text{ °C} / 100\text{ °F}$
 Liquid temperature $t_l = 37\text{ °C} / 98\text{ °F}$
 Evaporating temperature $t_e = 4.4\text{ °C} / 40\text{ °F}$

⁽²⁾ UL Listed

Table 6: AKV 20

Valve type	Rated capacity ⁽³⁾														kv valve[m ³ h]	Connections Solder ODF			Code no.
	R22		R134a		R407C		R404A/ R507		R407A		R410A		R744			Inlet × outlet[in]	Inlet × outlet[mm]	Multi-pack Code no.	
	[kW]	[TR]	[kW]	[TR]	[kW]	[TR]	[kW]	[TR]	[kW]	[TR]	[kW]	[TR]	[kW]	[TR]					
AKV 20-1	103	29.2	79.5	22.6	108	30.8	72	20.6	102	28.9	120	34.2	131	37.2	1	1 3/8 × 1 3/8	35 × 35	-	042H2020
	103	29.2	79.5	22.6	108	30.8	72	20.6	102	28.9	120	34.2	131	37.2	1	-	-	1 1/4 × 1 1/4	042H2021
AKV 20-2	164	46.6	127	36	173	49.2	115	32.9	162	46.1	192	54.7	210	59.7	1.6	1 3/8 × 1 3/8	35 × 35	-	042H2022
	164	46.6	127	36	173	49.2	115	32.9	162	46.1	192	54.7	210	59.7	1.6	-	-	1 1/4 × 1 1/4	042H2023
AKV 20-3	255	72.6	197	55.9	269	76.5	180	51.2	252	71.7	300	85.3	328	93.3	2.5	-	42 × 42	-	042H2025
	255	72.6	197	55.9	269	76.5	180	51.2	252	71.7	300	85.3	328	93.3	2.5	1 5/8 × 1 5/8	-	-	042H2024
	255	72.6	197	55.9	269	76.5	180	51.2	252	71.7	300	85.3	328	93.3	2.5	-	-	1 1/4 × 1 1/4	042H2026
AKV 20-4	405	115	311	88.3	426	121	286	81.4	400	114	477	136	526	150	4	2 1/8 × 2 1/8	54 × 54	-	042H2027
	405	115	311	88.3	426	121	286	81.4	400	114	477	136	526	150	4	-	-	1 1/4 × 1 1/4	042H2028
AKV 20-5	631	179	478	136	660	188	446	127	620	176	746	212	835	237	6.3	2 1/8 × 2 1/8	54 × 54	-	042H2029
	631	179	478	136	660	188	446	127	620	176	746	212	835	237	6.3	-	-	2 × 2	042H2030

⁽³⁾ Rated capacities are based on:
 Condensing temperature $t_c = 38\text{ °C} / 100\text{ °F}$
 Liquid temperature $t_l = 37\text{ °C} / 98\text{ °F}$
 Evaporating temperature $t_e = 4.4\text{ °C} / 40\text{ °F}$

⚠ WARNING:

AKV 20 are not suitable for R744 applications with media temperatures constantly below 0 °C. For other media temperatures, please contact Danfoss.

Design

Table 7: Design

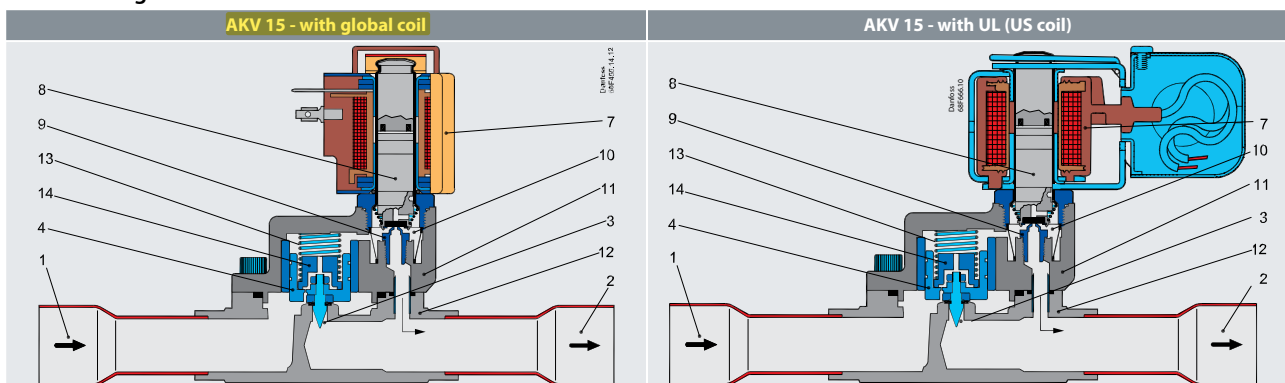

AKV 15 - with global coil

Figure 5: AKV 15 - with global coil

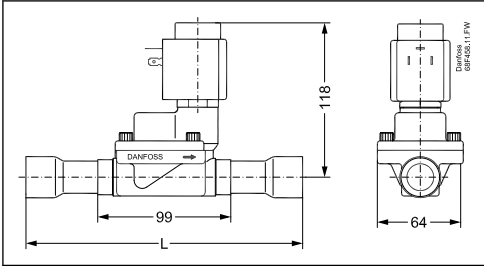

Table 9: AKV 15 - with global coil

Valve type	Inlet	Outlet	Inlet	Outlet	L	Net weight without coil
	[in.]	[in.]	[mm]	[mm]	[mm]	[kg]
AKV 15-1	3/4	3/4	18	18	190	1.5
AKV 15-2	3/4	3/4	18	18	190	1.5
AKV 15-3	7/8	7/8	22	22	190	1.5
AKV 15-4	1 1/8	1 1/8	28	28	216	1.5

AKV 15 - with BJ/BX coil

Table 10: AKV 15 - with BJ/BX coil

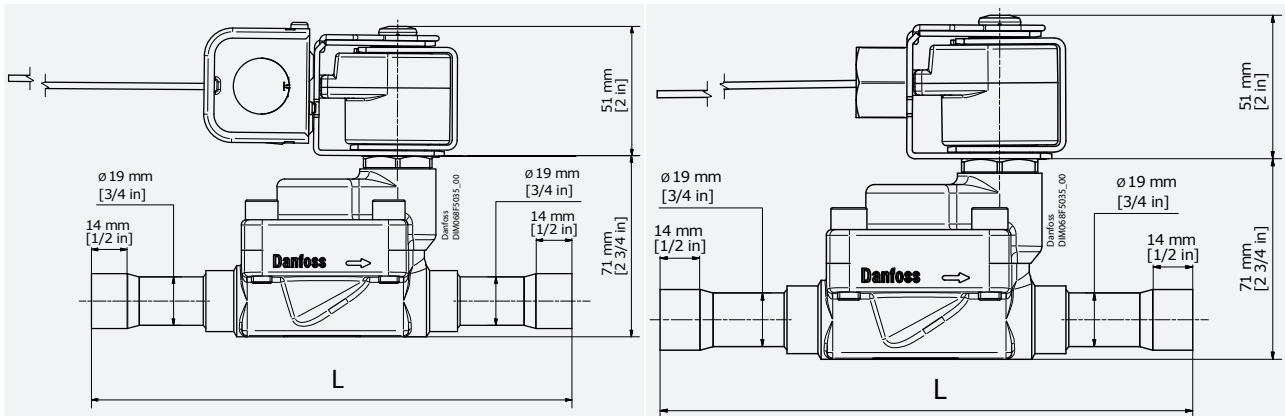

Table 11: AKV 15 - with BJ/BX coil

Valve type	Inlet [inch]	Outlet [inch]	L [inch]	Net weight without coil [kg]
AKV 15-1	3/4	3/4	7.48	3.31
AKV 15-2	3/4	3/4	7.48	3.31
AKV 15-3	7/8	7/8	7.48	3.31
AKV 15-4	1 1/8	1 1/8	8.5	3.31

Appendix 1

Dimensioning of the liquid line (R22/R407C, R134a, R404A, R507)

Table 12: Appendix 1

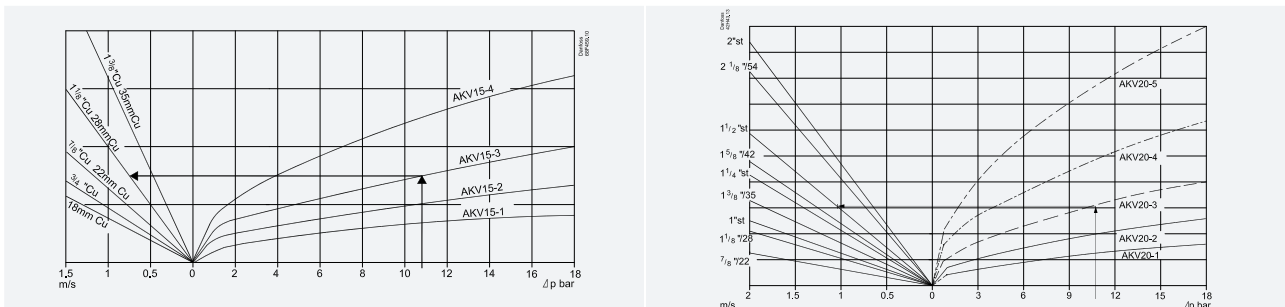

Ordering

Standard global coils

Table 13: Standard global coils

Supply voltage/power/ frequency	Connection type/enclosure rating	Code no.	AKV		
			15-1 15-2 15-3 15-4	20-1 20-3 20-2	20-4 20-5
DC coils					
220 V DC 20 W, standard	with terminal box	018F6851	+	+	+
100 V DC 18 W, special	with terminal box	018F6780	+	+	+
	with DIN plugs	—			
230 V DC 18 W, special	with terminal box	018F6781 ⁽¹⁾	+	+	+
	with DIN plugs	018F6991 ⁽¹⁾			
230 V DC 18 W, special	with 2.5 m cable	018F6288 ⁽¹⁾	+	+	+
	with 4.0 m cable	018F6278 ⁽¹⁾			
	with 8.0 m cable	018F6279 ⁽¹⁾			
AC coils					
240 V AC 10 W, 50 Hz	with terminal box	018F6702	+	-	-
	with DIN plugs	018F6177			
240 V AC 10 W, 60 Hz	with terminal box	018F6713	+	-	-
	with DIN plugs	—			
240 V AC 12 W, 50 Hz	with terminal box	018F6802	+	+	-
230 V AC 10 W, 50 Hz	with terminal box	018F6701	+	-	-
	with DIN-plugs	018F6176			
230 V AC 10 W, 60 Hz	with terminal box	018F6714	+	-	-
	with DIN-plugs	018F6189			
230 V AC 10 W, 50/60 Hz	with terminal box	018F6732	+	-	-
	with DIN-plugs	018F6193			
230 V AC 12 W, 50 Hz	with terminal box	018F6801	+	+	-
230 V AC 12 W, 60 Hz	with terminal box	018F6814	+	+	-
230 V AC 20 W, 50 Hz	with terminal box	018F6905 ⁽²⁾	+	+	+
115 V AC 10 W, 50 Hz	with terminal box	018F6711	+	-	-
	with DIN-plugs	—			
115 V AC 10 W, 60 Hz	with terminal box	018F6710	+	-	-
	with DIN-plugs	018F6185			
110 V AC 12 W, 50 Hz	with terminal box	018F6811	+	+	-
110 V AC 12 W, 60 Hz	with terminal box	018F6813	+	+	-
110 V AC 20 W, 50 Hz	with terminal box	018Z6904	+	+	+
24 V AC 10 W, 50 Hz	with terminal box	018F6707	+	-	-
	with DIN-plugs	018F6182			
24 V AC 10 W, 60 Hz	with terminal box	018F6715	+	-	-
	with DIN-plugs	—			
24 V AC 12 W, 50 Hz	with terminal box	018F6807	+	+	+
24 V AC 12 W, 60 Hz	with terminal box	018F6815	+	+	+
24 V AC 20 W, 50 Hz	with terminal box	018F6904 ⁽²⁾	+	+	+
24 V AC 20 W, 60 Hz	with terminal box	018F6902 ⁽²⁾	+	+	+

⁽¹⁾ Recommended for commercial refrigeration plant.

⁽²⁾ 20 W coils can not be connected to AKC 24P2 and AKC 24W2.