

CORESENSE™ DIAGNOSTICS FOR COPELAND STREAM™ COMPRESSORS QUICK INSTALLATION GUIDE

1. Remove the CoreSense™ front module cover by unscrewing the 4 screws in the corners.

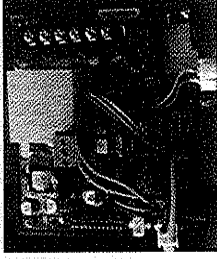
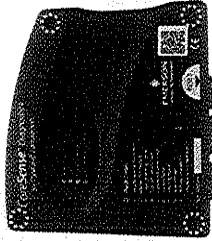

2. Check DIP-switch settings.

DIP-switch	DIP switch meaning	Default	Comment
1	Node address	On	Change it only if communication with pack controller is used
2	Node address	Off	Change it only if communication with pack controller is used
3	Node address	Off	Change it only if communication with pack controller is used
4	Node address	Off	Change it only if communication with pack controller is used
5	Node address	Off	Change it only if communication with pack controller is used
6	Node address	Off	Change it only if communication with pack controller is used
7	Communication Baud rate	Off	Change it only if communication with pack controller is used (Off: 19200; On: 9600)
8	Communication parity	Off	Change it only if communication with pack controller is used (Off: No parity, On: Even parity)
9	Communication with pack controller or service laptop	Off	Change it only if communication with pack controller or service laptop is used (Off: Stand-alone mode; On: Communication mode)
10	DLT probe	On	Change it only if DLT probe is disconnected (Off: DLT probe disconnected; On: DLT probe connected)
11	Oil pressure test	Off	Self test function for oil functionality (Off: no test; On: within 5 seconds of power up = test mode)
12	Enable frequency inverter	Off	Change it only if frequency inverter is used (On: VFD Application; Off: Non VFD Application)

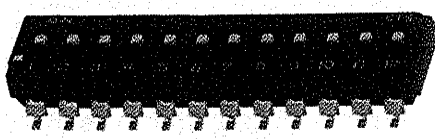

3. Check jumper settings (only if communication with pack controller is used). Please refer to label inside the module or guidelines for more details.

4. Supply 110/220 VAC power to the front module. Make wiring to contactor, line, alarm and protective earth (grounding). For cables use the opening at the bottom right of the module.

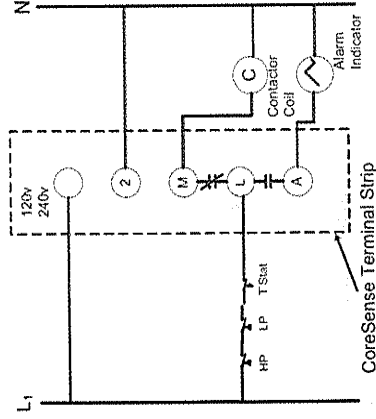

220 VAC
or
110 VAC

M – Contactor
L – Line
A – Alarm
P – Protective earth

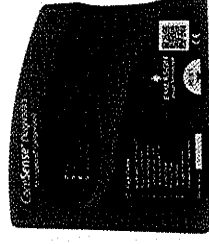

Sensor module wiring diagram

CoreSense terminal strip

Opening for the cables

5. In case of direct-start connection, L2 power supply lead; in case of part winding connection, L2 and L8 power leads from the customer should go through the current sensor opening in the same direction.

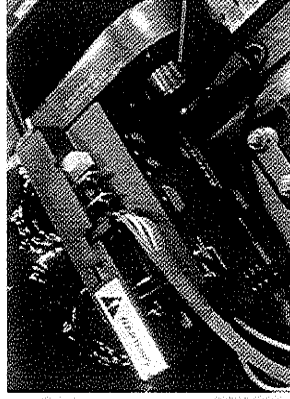

Current sensor opening

6. Make sure that the black lead from the sensor module is always connected to terminal 2 (factory-installed). The black lead from the sensor module must always be connected to that terminal off which the power supply cable is lead through current sensor.

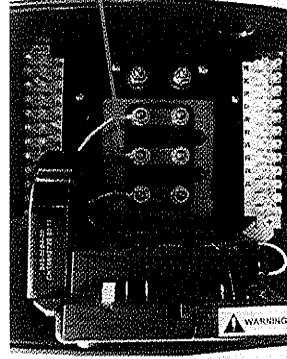

Black lead from sensor module (done in the factory)

7. Supply 24 VAC power to the sensor module. Any class II transformer with 24 VAC output can be used. The sensor module needs 3 VA power input. The transformer is available as an accessory. This step is not needed on Stream condensing units, as the power supply to the sensor module is already connected.

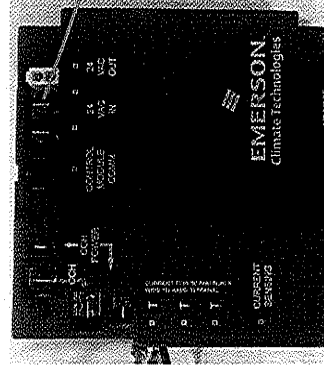

24 VAC power supply

8. Connect the crankcase heater to the sensor module (optional). The sensor module has a relay to control the crankcase heater (only 120/240 VAC).

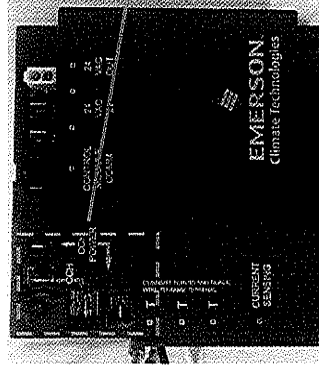

Crankcase heater connection point

NOTE: This document is for quick installation purposes. For detailed instructions, please refer to Technical Information D7.8.4 “CoreSense™ Diagnostics for Stream refrigeration compressors”.