

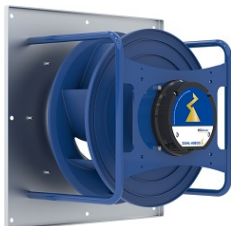

1



GR28C-6ID.BD.CR | 115667/A01 | Portfolio STD-WW | Cpro ECblue

Standard design with ECblue motor and integrated electronics

Material of impeller:

- ZAmid - high performance composite material

Color Coating:

- Color coating in RAL5002 (Ultra marine-blue)

Mains voltage motor size B_:

- 1~ 200...277 V; 50/60 Hz

Mains voltage motor size D_:

- 1~ 200...277 V; 50/60 Hz
- 3~ 200...240 V; 50/60 Hz
- 3~ 380...480 V; 50/60 Hz

Mains voltage motor size G_:

- 3~ 200...240 V; 50/60 Hz
- 3~ 380...480 V; 50/60 Hz

Thermal class:

- THCL155

Thermal protection:

- Protection with active temperature management

Protection:

- IP54

Coating:

- Motor painted in RAL5002 (Ultra marine-blue)

Controller (only motor size B_):

- Activation via external speed setting 0-10 V / PWM, Communication interface on request
- Standard cable length: 60 cm

Controller (only motor size D_, G_):

FANselect



- **BASIC:**

Activation via external speed setting 0-10 V / PWM Art. no. ER- and GR-module
in basic version

- **PREMIUM:**

Integrated control functionality, Communication interface on request

Cable glands:

- Motor size D: 3 x M16 x 1.5
- Motor size G: 3 x M20 x 1.5

Ambient temperature:

- Minimum permissible ambient temperature: -20 °C*
- Maximum permissible ambient temperature: 40 °C or see data sheet

***Continuous operation with occasional starts (S1) according to DIN EN 60034-1: 2011-02. Occasional starting between -35 ° C and -25 ° C is permissible. Permanent operation below -25 ° C only possible with special bearings for refrigeration applications on request.**



fan data

16/12/2021

version FANselect V 1.01 (211209), AMCA V 1.03 September, 2021 / 1.21.12.09 | 53567 | (user ZAFS43567)

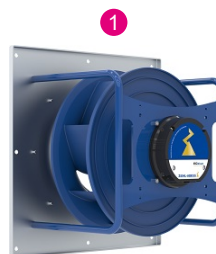

type	GR28C-6ID.BD.CR
article no.	115667/A01 Portfolio STD-WW

technical data

motor	ECblue	
Efficiency class	IE4	
mains supply	-	1~ 230V 50Hz
ambient temperature, max. limit (t_r)	°C	40
efficiency grade η_{statA}	%	68,6
efficiency grade N_{actual} N_{target}		80,2 62
ErP-conformity		2015 EC controller integrated
grille influence		no

fan data

SFP-class SFP-value (P_{SFP})	- Ws/m^3	3 1191
airflow volume (q_v)	ft^3/min	1386.1
air velocity	ft/s	28.10
pressure, stat. (p_{sF}) tot. (p_F)	in.wg.	2.978 3.150
electrical power input (P_{sys})	W	779
system eff., stat. ($\eta_{sF,sys}$) tot. ($\eta_{F,sys}$)	%	62.3 65.9
fan speed (n) max. (n_{max})	rpm	2959 2960
fan speed, set value ($\%n_{max}$)	%	100
frequency (f_{BP}) (f_{max})	Hz	50 60
voltage (U_{DP})	V	230
current (I_{DP})	A	3.42
acoustics, suction side ($L_{w(A),5}$) ($L_{w,5}$)	dB	74 77
acoustics, pressure side ($L_{w(A),6}$) ($L_{w,6}$)	dB	80 82
dimensions (w x h x d)	in	16.14 x 16.14 x 11.77
product weight (m_{pr})	lb	28.7
k-factor nozzle pres. (k)	-	75
differential pres. nozzle ($p_{sF \text{ nozzle}}$)	Pa	986

PF:PF_50; Ano:115667; STot:+-10 %





performance curve / acoustics

16/12/2021

version FANselect V 1.01 (211209), AMCA V 1.03 September, 2021 / 1.21.12.09 | 53567 | (user ZAFS43567)

- 1 **GR28C-6ID.BD.CR** measured in standard nozzle in installation type A according to ISO 5801
 115667/A01 | Portfolio measurement density 0.072 [lbs/ft³]
 STD-WW

air performance p_{sF}

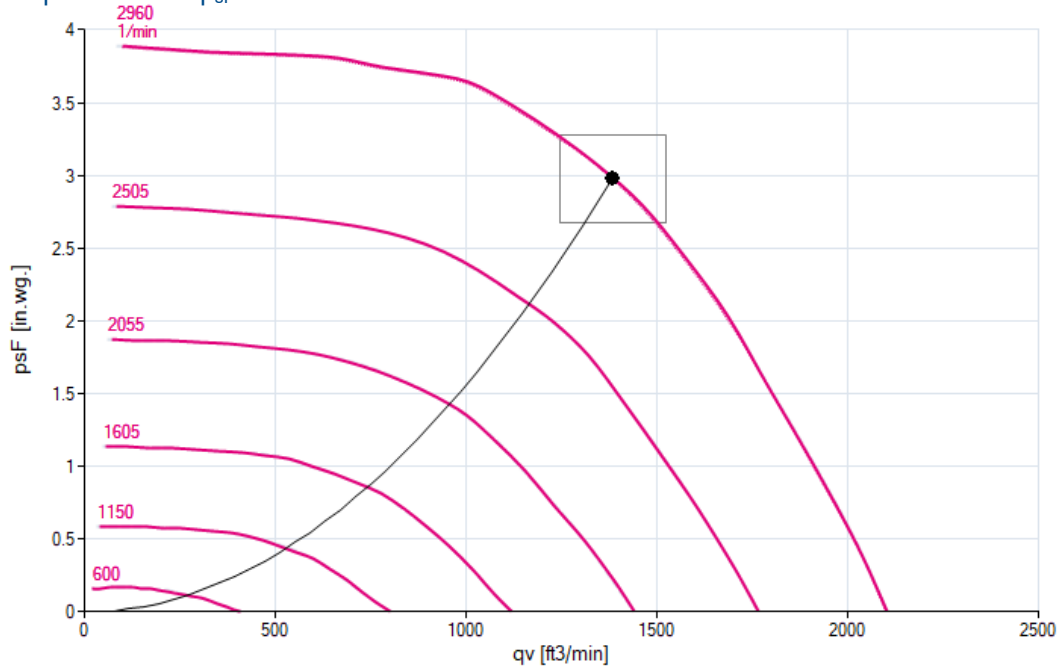

acoustics (L_{w(A),5})

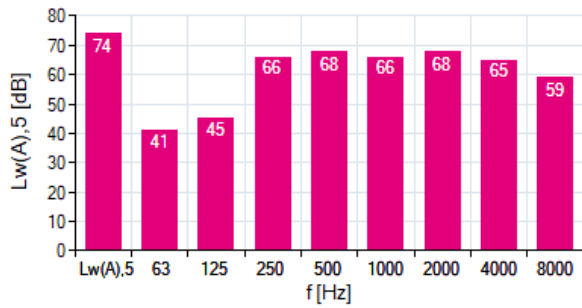

acoustics (L_{w(A),6})

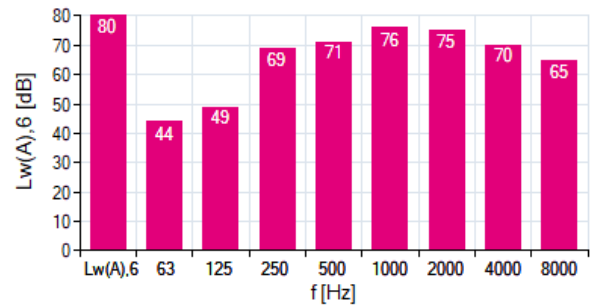

1 GR28C-6ID.BD.CR

f [Hz]	sum	63	125	250	500	1000	2000	4000	8000
L _{w(A),5}	74	41	45	66	68	66	68	65	59
L _{w,5}	77	69	62	73	70	66	66	64	59

f [Hz]	sum	63	125	250	500	1000	2000	4000	8000
L _{w(A),6}	80	44	49	69	71	76	75	70	65
L _{w,6}	82	71	66	76	74	76	74	69	66

FANselect



efficiency grade / power input 16/12/2021
version FANselect V 1.01 (211209), AMCA V 1.03 September, 2021 / 1.21.12.09 | 53567 | (user ZAFS43567)

1 **GR28C-6ID.BD.CR** measured in standard nozzle in installation type A according to ISO 5801
115667/A01 | Portfolio measurement density 0.072 [lbs/ft³]
STD-WW

efficiency grade $\eta_{F,sys}$

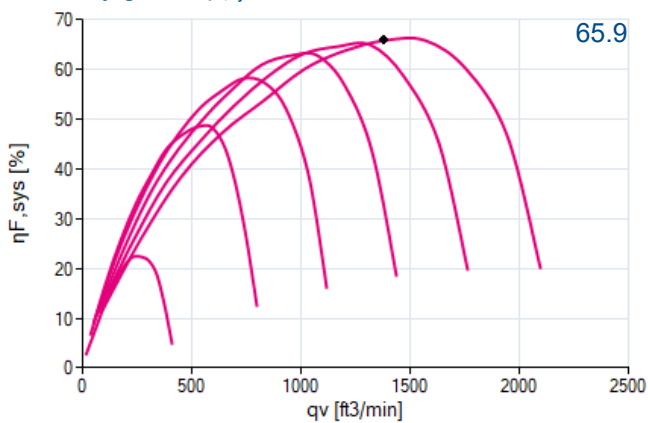

efficiency grade $\eta_{SF,sys}$

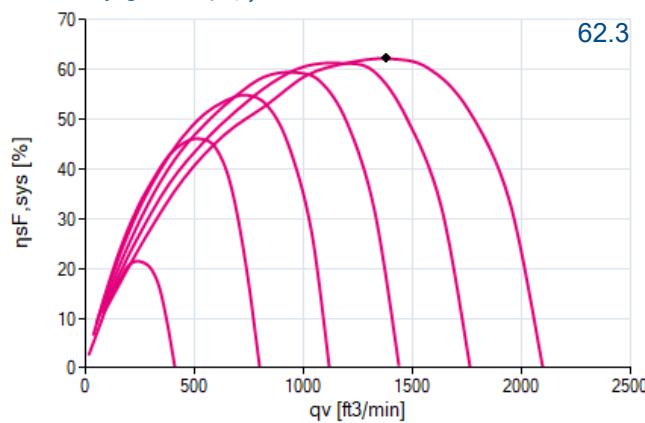

power input P_{sys}

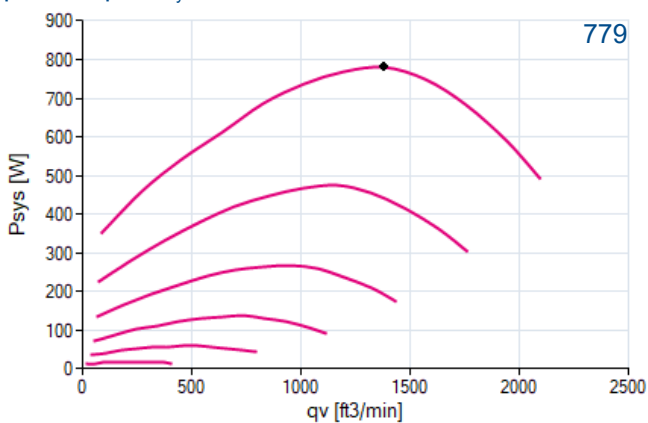



nominal values

16/12/2021

version FANselect V 1.01 (211209), AMCA V 1.03 September, 2021 / 1.21.12.09 | 53567 | (user ZAFS43567)

1

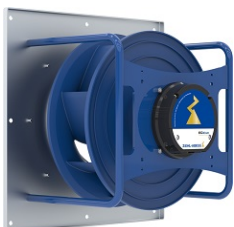

GR28C-6ID.BD.CR

115667/A01

1~ 200-277V 50Hz P1 0.78kW
 3.90-2.80A 2960/MIN 40°C
 1~ 200-277V 60Hz P1 0.78kW
 3.90-2.80A 2960/MIN 40°C
 IP54 THCL155

drawing

16/12/2021

version FANselect V 1.01 (211209), AMCA V 1.03 September, 2021 / 1.21.12.09 | 53567 | (user ZAFS43567)

1

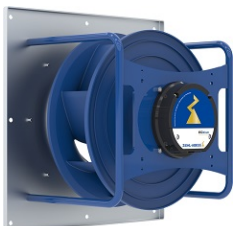

GR28C-6ID.BD.CR

115667/A01

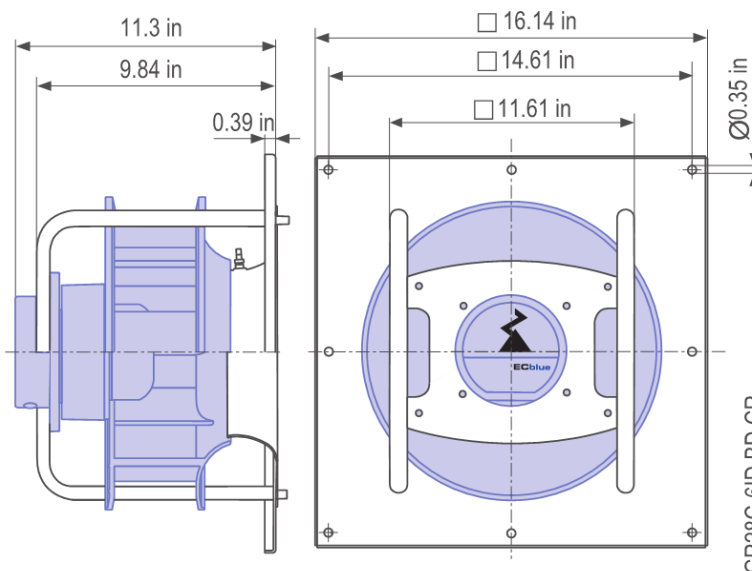

wiring diagram

16/12/2021

version FANselect V 1.01 (211209), AMCA V 1.03 September, 2021 / 1.21.12.09 | 53567 | (user ZAFS43567)

1

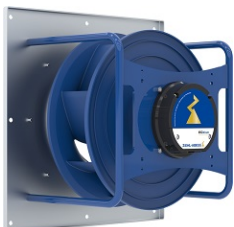

GR28C-6ID.BD.CR

115667/A01

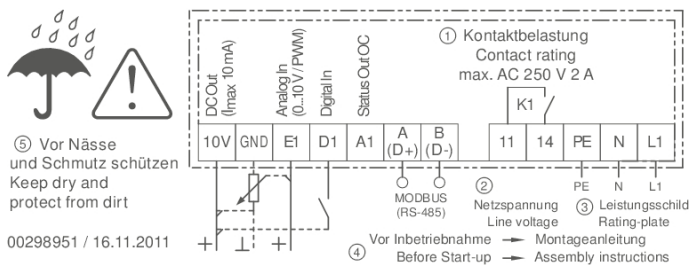



system components

16/12/2021

version FANselect V 1.01 (211209), AMCA V 1.03 September, 2021 / 1.21.12.09 | 53567 | (user ZAFS43567)



type	GR28C-6ID.BD.CR
article no.	115667/A01