



## general description

15/12/2021

version FANselect V 1.01 (211209), AMCA V 1.03 September, 2021 / 1.21.12.09 | 53567 | (user ZAFS43567)

1

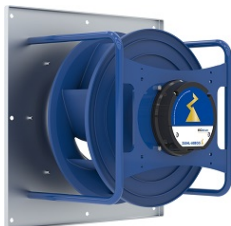

GR31C-ZID.DC.CR | 116166/A01 | Portfolio STD-WW | Cpro ECblue

**Standard design with ECblue motor and integrated electronics****Material of impeller:**

- ZAmid - high performance composite material

**Color Coating:**

- Color coating in RAL5002 (Ultra marine-blue)

**Mains voltage motor size B\_:**

- 1~ 200...277 V; 50/60 Hz

**Mains voltage motor size D\_:**

- 1~ 200...277 V; 50/60 Hz
- 3~ 200...240 V; 50/60 Hz
- 3~ 380...480 V; 50/60 Hz

**Mains voltage motor size G\_:**

- 3~ 200...240 V; 50/60 Hz
- 3~ 380...480 V; 50/60 Hz

**Thermal class:**

- THCL155

**Thermal protection:**

- Protection with active temperature management

**Protection:**

- IP55

**Coating:**

- Motor painted in RAL5002 (Ultra marine-blue)

**Controller (only motor size B\_):**

- Activation via external speed setting 0-10 V / PWM, Communication interface on request
- Standard cable length: 60 cm

**Controller (only motor size D\_, G\_):**

# FANselect



- **BASIC:**

Activation via external speed setting 0-10 V / PWM Art. no. ER- and GR-module  
in basic version

- **PREMIUM:**

Integrated control functionality, Communication interface on request

**Cable glands:**

- Motor size D: 3 x M16 x 1.5
- Motor size G: 3 x M20 x 1.5

**Ambient temperature:**

- Minimum permissible ambient temperature: -20 °C\*
- Maximum permissible ambient temperature: 40 °C or see data sheet

**\*Continuous operation with occasional starts (S1) according to DIN EN 60034-1: 2011-02. Occasional starting between -35 ° C and -25 ° C is permissible. Permanent operation below -25 ° C only possible with special bearings for refrigeration applications on request.**



## fan data

15/12/2021

version FANselect V 1.01 (211209), AMCA V 1.03 September, 2021 / 1.21.12.09 | 53567 | (user ZAFS43567)



type	GR31C-ZID.DC.CR
article no.	116166/A01   Portfolio STD-WW

## technical data

motor	ECblue	
Efficiency class	IE5	
mains supply	-	3~ 400V 50Hz
ambient temperature, max. limit ( $t_r$ )	°C	45
efficiency grade $\eta_{statA}$	%	65,0
efficiency grade $N_{actual}$   $N_{target}$		<b>69,6</b>   62
ErP-conformity		2015   EC controller integrated
grille   influence		no

## fan data

<b>SFP-class</b>   SFP-value ( $P_{SFP}$ )	-   Ws/m <sup>3</sup>	<b>4</b>   1947
airflow volume ( $q_v$ )	ft <sup>3</sup> /min	3507.6
air velocity	ft/s	56.87
pressure, <b>stat.</b> ( $p_{sF}$ )   tot. ( $p_F$ )	in.wg.	<b>3.862</b>   4.579
electrical power input ( $P_{sys}$ )	W	3223
system eff., <b>stat.</b> ( $\eta_{sF,sys}$ )   tot. ( $\eta_{F,sys}$ )	%	<b>49.4</b>   58.6
fan speed ( <b>n</b> )   max. ( $n_{max}$ )	rpm	<b>4096</b>   4100
fan speed, set value (% $n_{max}$ )	%	100
frequency ( <b>f<sub>BP</sub></b> )   ( $f_{max}$ )	Hz	<b>50</b>   60
voltage ( $U_{DP}$ )	V	400
current ( $I_{DP}$ )	A	4.92
acoustics, suction side ( $L_{w(A),5}$ )   ( $L_{w,5}$ )	dB	<b>90</b>   93
acoustics, pressure side ( $L_{w(A),6}$ )   ( $L_{w,6}$ )	dB	<b>97</b>   98
dimensions (w x h x d)	in	17.72 x 17.72 x 13.50
product weight ( $m_{pr}$ )	lb	44.1
k-factor nozzle pres. (k)	-	95
differential pres. nozzle ( $p_{sF \text{ nozzle}}$ )	Pa	3935

PF:PF\_50; BR:BR\_40;  $q_v$ :3000.0 ft<sup>3</sup>/min;  $p_{sF}$ :2.000 in.wg.; mains:3~ / 400V / 50 Hz;  $t_r$ :40 °C; size:315 mm;  $p$ :0.072 lbs/ft<sup>2</sup>; STol:+-10 %; BF:





## performance curve / acoustics

15/12/2021

version FANselect V 1.01 (211209), AMCA V 1.03 September, 2021 / 1.21.12.09 | 53567 | (user ZAFS43567)

- 1 **GR31C-ZID.DC.CR** measured in standard nozzle in installation type A according to ISO 5801  
 116166/A01 | Portfolio measurement density 0.072 [lbs/ft<sup>3</sup>]  
 STD-WW

### air performance p<sub>sF</sub>

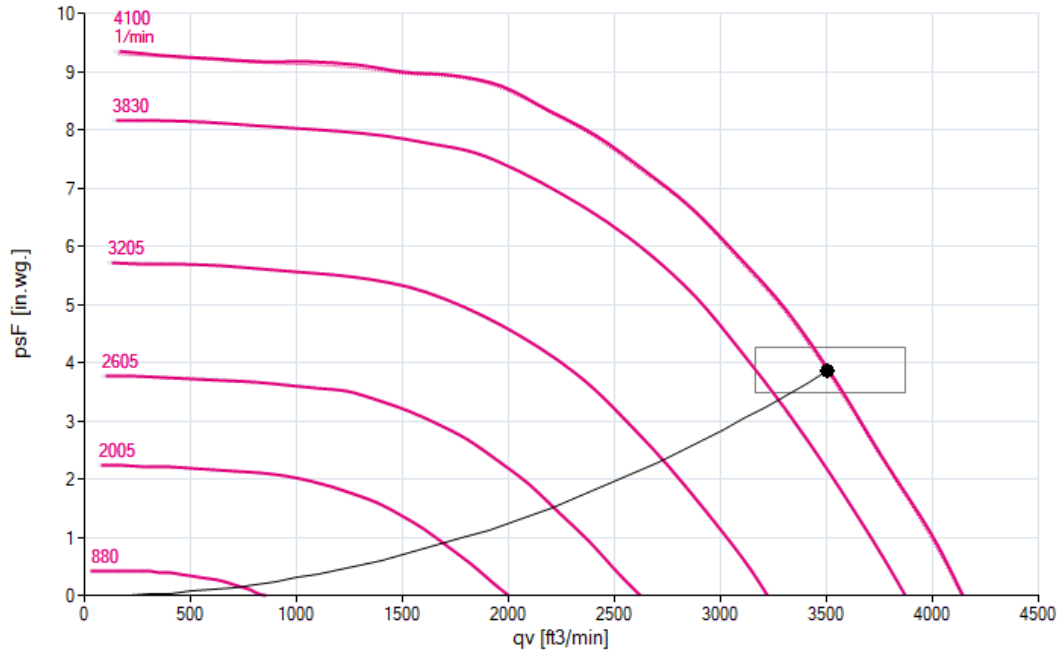

### acoustics (L<sub>w(A),5</sub>)

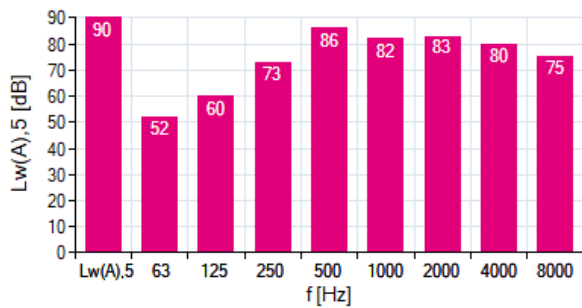

### acoustics (L<sub>w(A),6</sub>)

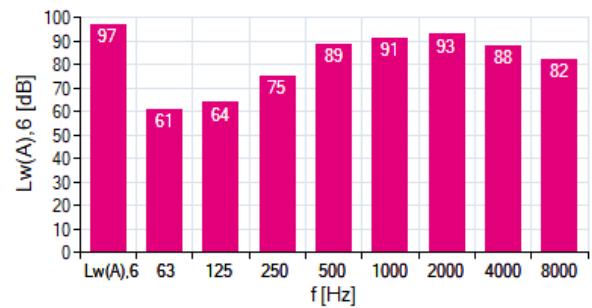

### 1 GR31C-ZID.DC.CR

f [Hz]	sum	63	125	250	500	1000	2000	4000	8000
L <sub>w(A),5</sub>	90	52	60	73	86	82	83	80	75
L <sub>w,5</sub>	93	79	76	80	89	82	82	79	76

f [Hz]	sum	63	125	250	500	1000	2000	4000	8000
L <sub>w(A),6</sub>	97	61	64	75	89	91	93	88	82
L <sub>w,6</sub>	98	89	79	83	92	91	92	87	83

# FANselect



efficiency grade / power input 15/12/2021  
version FANselect V 1.01 (211209), AMCA V 1.03 September, 2021 / 1.21.12.09 | 53567 | (user ZAFS43567)

**1 GR31C-ZID.DC.CR** measured in standard nozzle in installation type A according to ISO 5801  
 116166/A01 | Portfolio measurement density 0.072 [lbs/ft<sup>3</sup>]  
 STD-WW

efficiency grade  $\eta_{F,sys}$

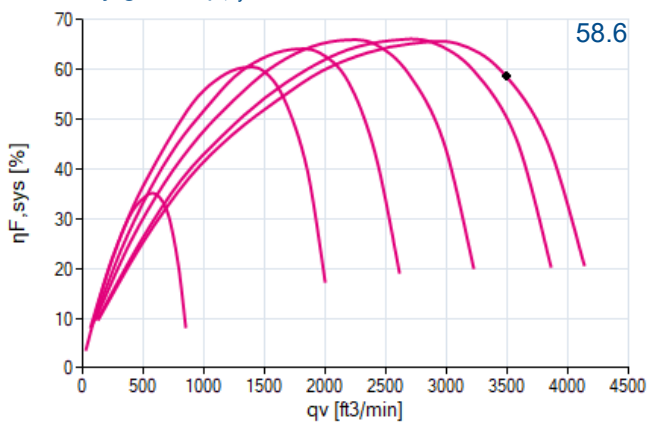

efficiency grade  $\eta_{SF,sys}$

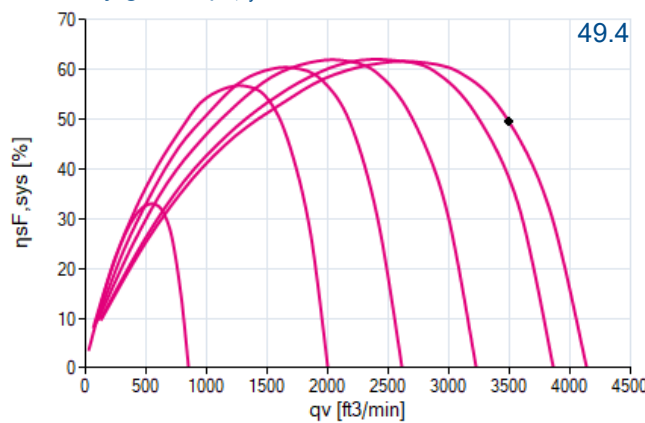

power input  $P_{sys}$

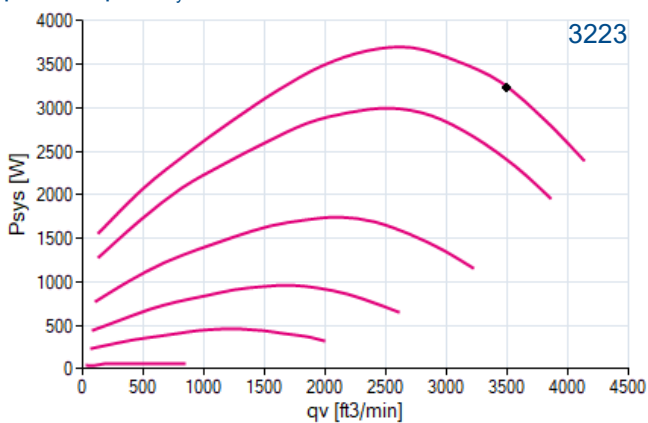



## nominal values

15/12/2021

version FANselect V 1.01 (211209), AMCA V 1.03 September, 2021 / 1.21.12.09 | 53567 | (user ZAFS43567)

1

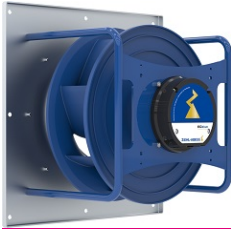

GR31C-ZID.DC.CR

116166/A01

3~ 380-480V 50Hz P1 3.70kW  
 6.00-4.60A 4100/MIN 45°C  
 3~ 380-480V 60Hz P1 3.70kW  
 6.00-4.60A 4100/MIN 45°C  
 IP55 THCL155

## drawing

15/12/2021

version FANselect V 1.01 (211209), AMCA V 1.03 September, 2021 / 1.21.12.09 | 53567 | (user ZAFS43567)

1

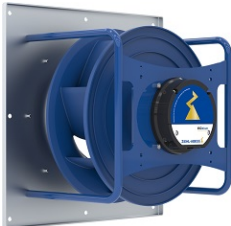

GR31C-ZID.DC.CR

116166/A01

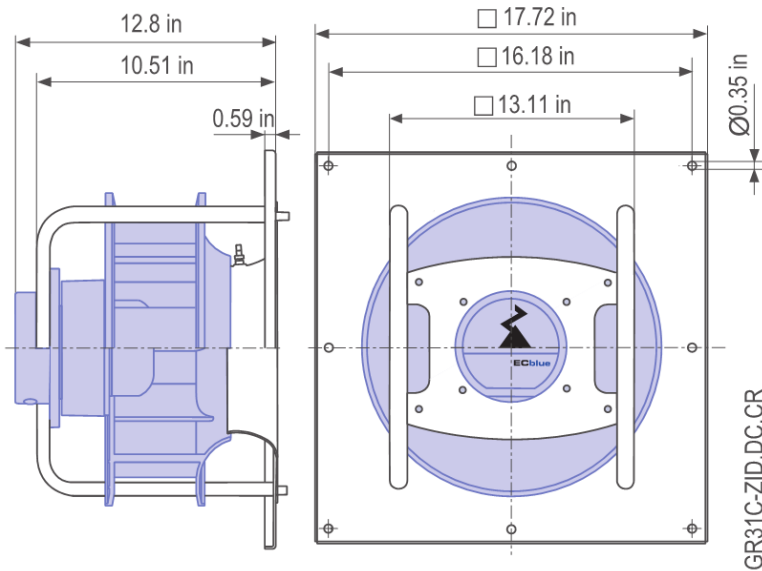

GR31C-ZID.DC.CR

## wiring diagram

15/12/2021

version FANselect V 1.01 (211209), AMCA V 1.03 September, 2021 / 1.21.12.09 | 53567 | (user ZAFS43567)

1

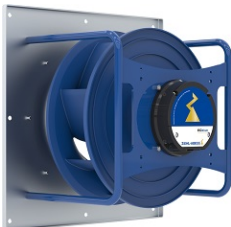

GR31C-ZID.DC.CR

116166/A01

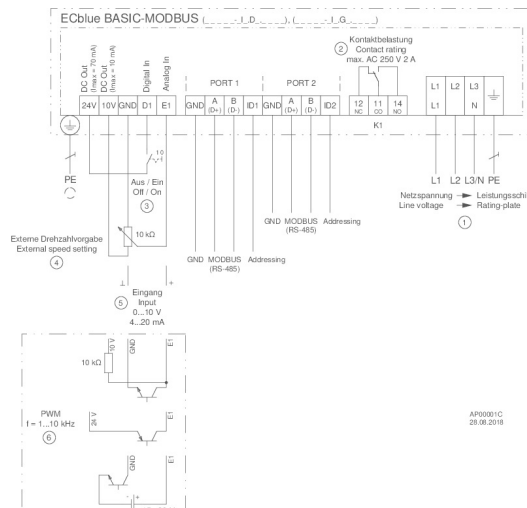



## system components

15/12/2021

version FANselect V 1.01 (211209), AMCA V 1.03 September, 2021 / 1.21.12.09 | 53567 | (user ZAFS43567)



type	GR31C-ZID.DC.CR
article no.	116166/A01