

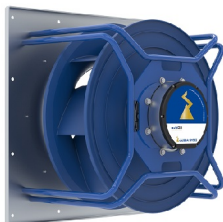

1



GR45C-ZIK.DG.CR | 116671/A01 | Portfolio STD-WW | Cpro ECblue

### Standard design with ECblue motor and integrated electronics

#### Material of impeller:

- ZAmid - high performance composite material

#### Color Coating:

- Color coating in RAL5002 (Ultra marine-blue)

#### Mains voltage motor size B\_:

- 1~ 200...277 V; 50/60 Hz

#### Mains voltage motor size D\_:

- 1~ 200...277 V; 50/60 Hz
- 3~ 200...240 V; 50/60 Hz
- 3~ 380...480 V; 50/60 Hz

#### Mains voltage motor size G\_:

- 3~ 200...240 V; 50/60 Hz
- 3~ 380...480 V; 50/60 Hz

#### Thermal class:

- THCL155

#### Thermal protection:

- Protection with active temperature management

#### Protection:

- IP55

#### Coating:

- Motor painted in RAL5002 (Ultra marine-blue)

#### Controller (only motor size B\_):

- Activation via external speed setting 0-10 V / PWM, Communication interface on request
- Standard cable length: 60 cm

#### Controller (only motor size D\_, G\_):

# FANselect



- **BASIC:**

Activation via external speed setting 0-10 V / PWM Art. no. ER- and GR-module  
in basic version

- **PREMIUM:**

Integrated control functionality, Communication interface on request

**Cable glands:**

- Motor size D: 3 x M16 x 1.5
- Motor size G: 3 x M20 x 1.5

**Ambient temperature:**

- Minimum permissible ambient temperature: -20 °C\*
- Maximum permissible ambient temperature: 40 °C or see data sheet

**\*Continuous operation with occasional starts (S1) according to DIN EN 60034-1: 2011-02. Occasional starting between -35 ° C and -25 ° C is permissible. Permanent operation below -25 ° C only possible with special bearings for refrigeration applications on request.**



## fan data

15/12/2021

version FANselect V 1.01 (211209), AMCA V 1.03 September, 2021 / 1.21.12.09 | 53567 | (user ZAFS43567)



type	GR45C-ZIK.DG.CR
article no.	116671/A01   Portfolio STD-WW

## technical data

motor	ECblue	
Efficiency class	IE5	
mains supply	-	3~ 400V 50Hz
ambient temperature, max. limit ( $t_r$ )	°C	40
efficiency grade $\eta_{statA}$	%	67,4
efficiency grade $N_{actual}$   $N_{target}$		73,1   62
ErP-conformity		2015   EC controller integrated
grille   influence		no

## fan data

SFP-class   SFP-value ( $P_{SFP}$ )	-   $Ws/m^3$	3   1220
airflow volume ( $q_v$ )	$ft^3/min$	4749.5
air velocity	$ft/s$	38.51
pressure, stat. ( $p_{sF}$ )   tot. ( $p_F$ )	in.wg.	2.959   3.281
electrical power input ( $P_{sys}$ )	W	2734
system eff., stat. ( $\eta_{sF,sys}$ )   tot. ( $\eta_{F,sys}$ )	%	60.4   67.0
fan speed ( $n$ )   max. ( $n_{max}$ )	rpm	2120   2120
fan speed, set value ( $\%n_{max}$ )	%	100
frequency ( $f_{BP}$ )   ( $f_{max}$ )	Hz	50   60
voltage ( $U_{DP}$ )	V	400
current ( $I_{DP}$ )	A	4.22
acoustics, suction side ( $L_{w(A),5}$ )   ( $L_{w,5}$ )	dB	83   89
acoustics, pressure side ( $L_{w(A),6}$ )   ( $L_{w,6}$ )	dB	89   93
dimensions (w x h x d)	in	23.62 x 23.62 x 15.39
product weight ( $m_{pr}$ )	lb	77.2
k-factor nozzle pres. (k)	-	197
differential pres. nozzle ( $p_{sF \text{ nozzle}}$ )	Pa	1678

PF:PF\_50; Ano:116671; STot:+-10 %





# FANselect

## performance curve / acoustics

15/12/2021

version FANselect V 1.01 (211209), AMCA V 1.03 September, 2021 / 1.21.12.09 | 53567 | (user ZAFS43567)

- 1 **GR45C-ZIK.DG.CR** measured in standard nozzle in installation type A according to ISO 5801  
 116671/A01 | Portfolio measurement density 0.072 [lbs/ft<sup>3</sup>]  
 STD-WWW

### air performance p<sub>sF</sub>

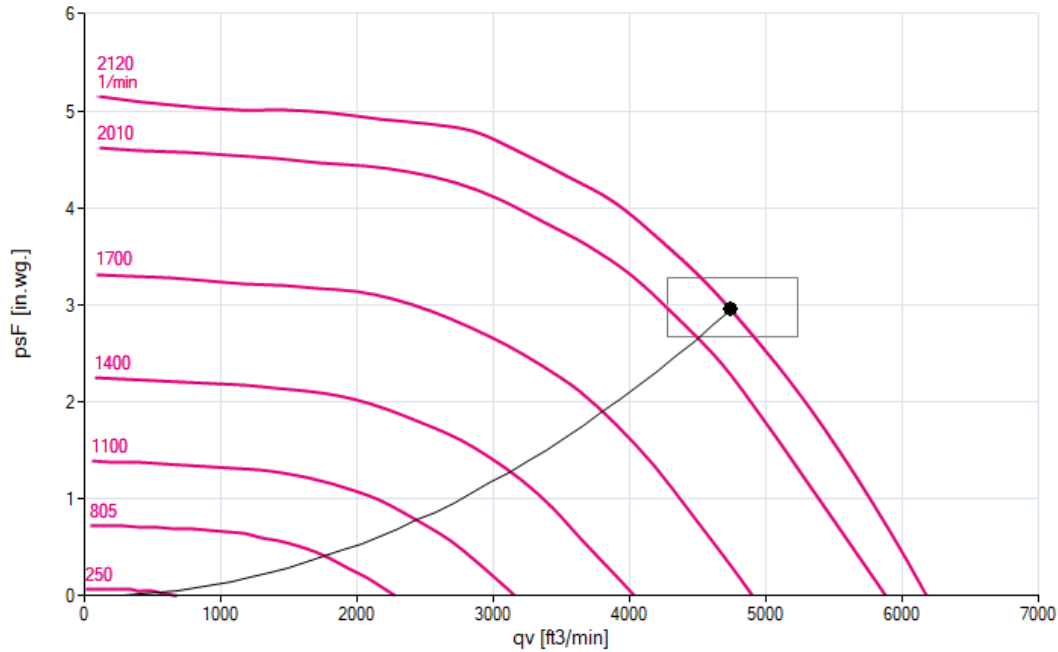

### acoustics (L<sub>w(A),5</sub>)

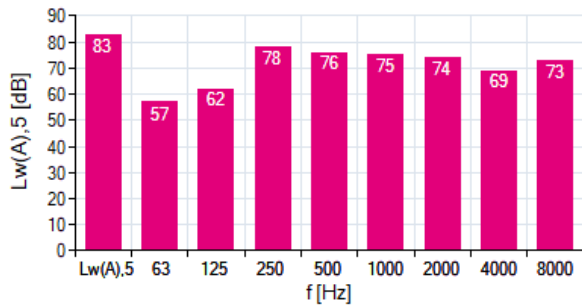

### acoustics (L<sub>w(A),6</sub>)

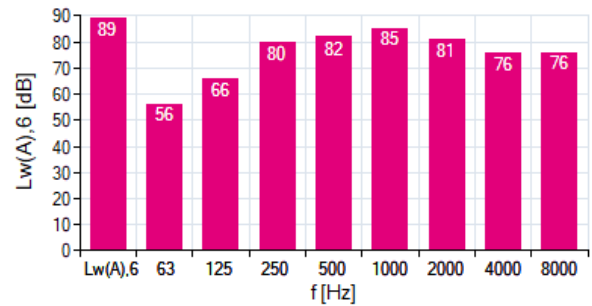

### 1 GR45C-ZIK.DG.CR

f [Hz]	sum	63	125	250	500	1000	2000	4000	8000
L <sub>w(A),5</sub>	83	57	62	78	76	75	74	69	73
L <sub>w,5</sub>	89	82	78	86	80	75	73	68	75

f [Hz]	sum	63	125	250	500	1000	2000	4000	8000
L <sub>w(A),6</sub>	89	56	66	80	82	85	81	76	76
L <sub>w,6</sub>	93	82	81	89	85	86	80	75	78

# FANselect



efficiency grade / power input 15/12/2021  
version FANselect V 1.01 (211209), AMCA V 1.03 September, 2021 / 1.21.12.09 | 53567 | (user ZAFS43567)

① **GR45C-ZIK.DG.CR** measured in standard nozzle in installation type A according to ISO 5801  
 116671/A01 | Portfolio measurement density 0.072 [lbs/ft<sup>3</sup>]  
 STD-WW

efficiency grade  $\eta_{F,sys}$

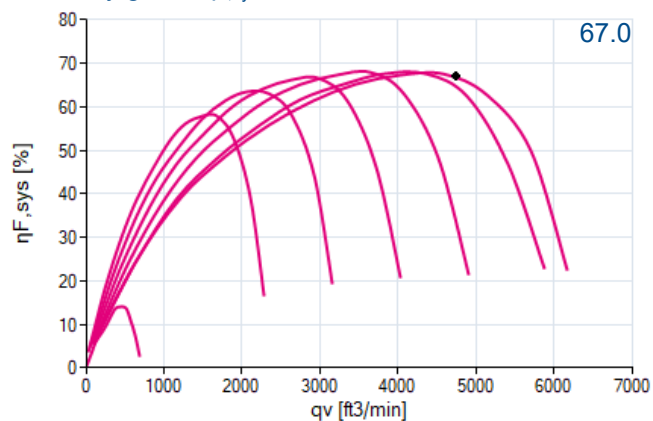

efficiency grade  $\eta_{SF,sys}$

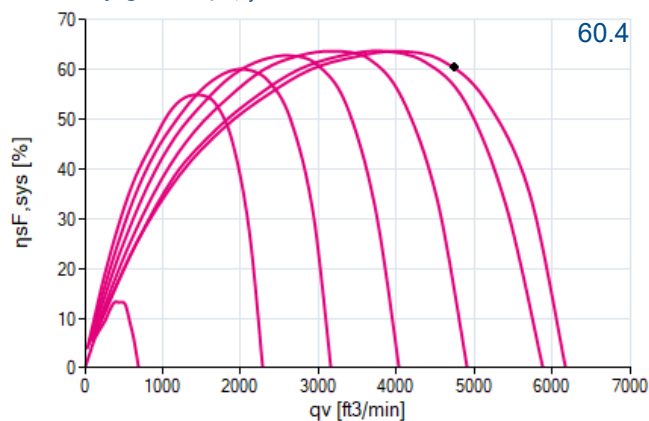

power input  $P_{sys}$

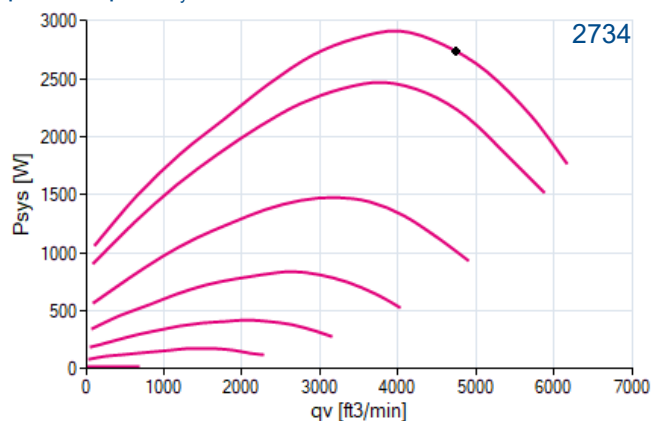



## nominal values

15/12/2021

version FANselect V 1.01 (211209), AMCA V 1.03 September, 2021 / 1.21.12.09 | 53567 | (user ZAFS43567)

1

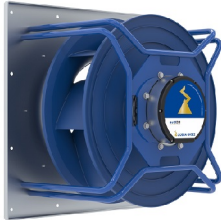

**GR45C-ZIK.DG.CR**  
116671/A01

3~ 380-480V 50Hz P1 2.90kW  
4.80-3.70A 2120/MIN 40°C  
3~ 380-480V 60Hz P1 2.90kW  
4.80-3.70A 2120/MIN 40°C  
IP55 THCL155

## drawing

15/12/2021

version FANselect V 1.01 (211209), AMCA V 1.03 September, 2021 / 1.21.12.09 | 53567 | (user ZAFS43567)

1

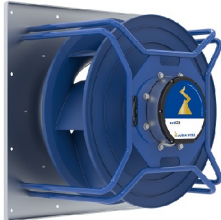

**GR45C-ZIK.DG.CR**  
116671/A01

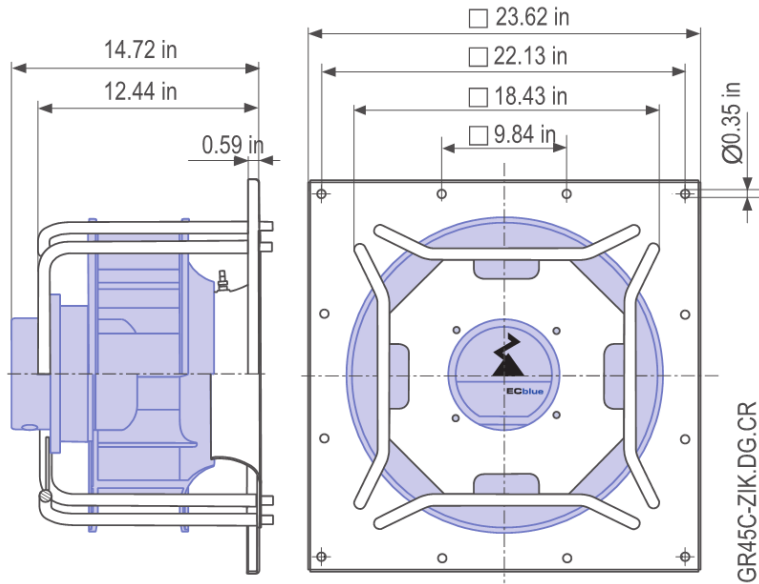

## wiring diagram

15/12/2021

version FANselect V 1.01 (211209), AMCA V 1.03 September, 2021 / 1.21.12.09 | 53567 | (user ZAFS43567)

1

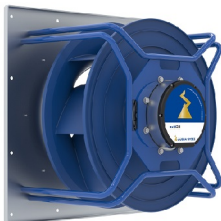

**GR45C-ZIK.DG.CR**  
116671/A01

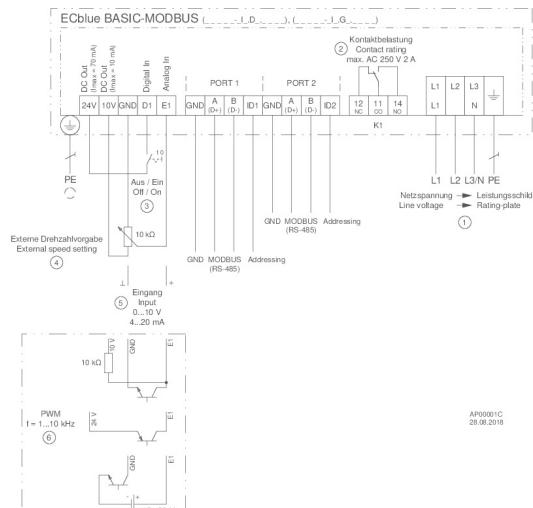



## system components

15/12/2021

version FANselect V 1.01 (211209), AMCA V 1.03 September, 2021 / 1.21.12.09 | 53567 | (user ZAFS43567)



type	GR45C-ZIK.DG.CR
article no.	116671/A01