

**Ventilateurs Hélices en matériaux composites
Compact VD/VIP/VIL :: Ref. 021311**

Famille	Ventilateurs Hélicoïdes
Type	Ventilateurs Hélices en matériaux composites
Gamme	Compact VD/VIP/VIL
Code Article	021311
Hélice	S0600 VIL44
Moteur	TG100L04
Alimentation	230 400
Vitesse de rotation	1500
Watts sur arbre	1450
Watts absorbés	1900
Indice de protection	IP54
Débit	16100
Masse	23
Classe	CL/F

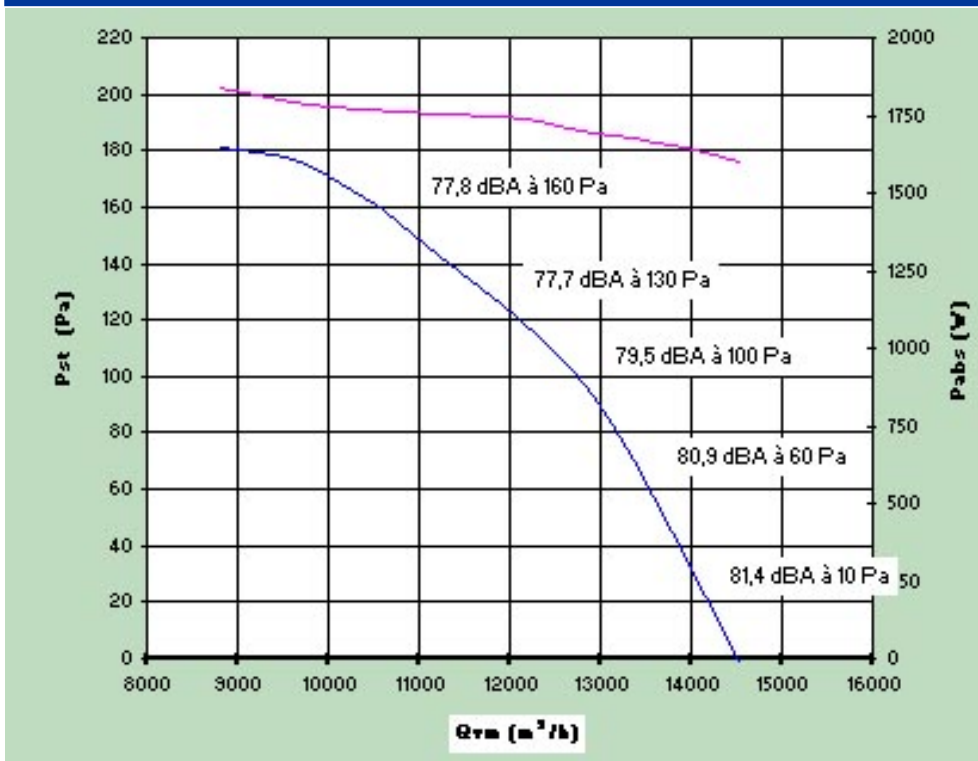

SCHEMA

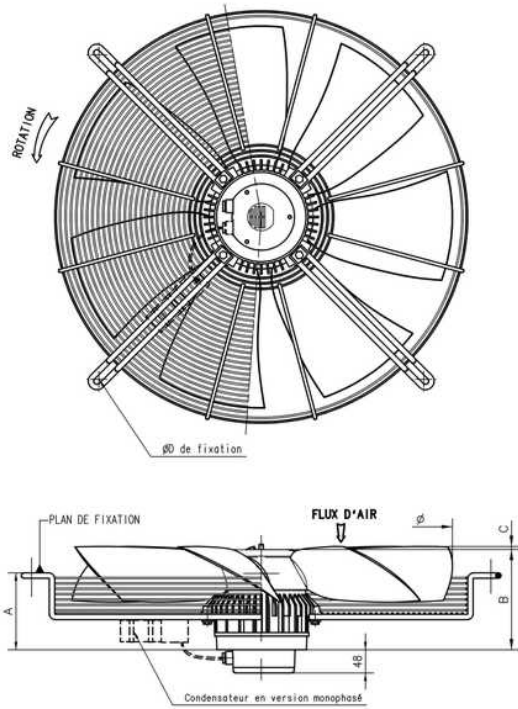

Ø	TYPE	MOTEUR	mm			Fixation	
			A	B	C	ØD	Vis
710	S710VIL51	TG80L6/8/12	143	187,5	5	853	M10
710	S710VIL51	TG100L6	163	207,5	5	853	M10
710	S710VIL44	TG80L6/8/12	143	187,5	0	853	M10
710	S710VIL38	TG80L6/8/12	143	187,5	0	853	M10
650	S650VIL51	TG100L6	163	207,5		750	M8
650	S650VIL51	TG80L6	143	187,5	5	750	M8
650	S650VIL51	TG65L8/12	128	172,5	5	750	M8
650	S650VIL44	TG65L6/8/12	128	172,5	0	750	M8
650	S650VIL38	TG50L6/8	113	157,5	0	750	M8
630	S630VIL51	TG80L6	143	187,5	5	750	M8
630	S630VIL51	TG65L8/12	128	172,5	5	750	M8
630	S630VIL44	TG65L6/8/12	128	172,5	0	750	M8
630	S630VIL38	TG80L4	143	187,5	0	750	M8
630	S630VIL38	TG50L6/8	113	157,5	0	750	M8
630	S630VIL44	TG50L6/8	113	157,5	0	750	M8
600	S600VIL51	TG65L6/8	128	172,5	5	700	M8
600	S600VIL51	TG80L6/8	143	187,5	5	700	M8
600	S600VIL44	TG100L4	163	207,5	0	700	M8
600	S600VIL44	TG50L6/8	113	157,5	0	700	M8
600	S600VIL38	TG80L4	143	187,5	0	700	M8
600	S600VIL38	TG50L8	113	157,5	0	700	M8
560	S560VIL51	TG100L4	163	207,5	5	700	M8
560	S560VIL51	TG50L6/8	113	157,5	5	700	M8
560	S560VIL44	TG80L4	143	187,5	0	700	M8
560	S560VIL44	TG50L8	113	157,5	0	700	M8
560	S560VIL38	TG65L4	128	172,5	0	700	M8
560	S560VIL38	TG50L8	113	157,5	0	700	M8
550	S550VIL44	TG50L6	113	157,5	0	700	M8
550	S550VIL51	TG100L4	163	207,5	5	700	M8

Les versions monophasées MCC ont le même encombrement que les versions triphasées TG.